



CITY

40582





Get excited about our new packaging!

We're switching from plastic to paper-based packaging. That's why you might find a mix of paper and plastic in our boxes!

Nos nouveaux emballages vous emballeront !

Nous passons des emballages en plastique aux emballages à base de papier. C'est pourquoi vous pourriez trouver un mélange de papier et de plastique dans nos boîtes !

¡Te presentamos nuestros nuevos empaques!

Estamos sustituyendo las bolsas de plástico por bolsas con base de papel. ¡Por eso, puedes encontrar una mezcla de papel y de plástico en nuestras cajas!

[LEGO.com/sustainable-packaging](https://www.lego.com/sustainable-packaging)



BUILDER



Apple and the Apple logo are trademarks of Apple Inc., registered in the U.S. and other countries and regions. App Store is a service mark of Apple Inc. Google Play and the Google Play logo are trademarks of Google LLC. Tencent and the Tencent logo are trademarks of Tencent Inc.

EN Ask parents' permission before going online | **DE** Eltern um Erlaubnis bitten, bevor du online gehst | **FR** Demande l'autorisation d'un parent avant d'aller en ligne | **IT** Chiedi il permesso ai tuoi genitori prima di andare online | **ES** Pídeles permiso a tus papás antes de conectarte a Internet | **PT** Pede autorização aos pais antes de acederes online | **JA** オンラインになる前に ほか者の方のきよかをもらおう | **ZH** 上网前应先征得父母的同意 | **KO** 온라인 접속 전에 보호자 동의가 필요합니다 | **RU** Спроси разрешения у родителей, прежде чем заходить в интернет | **PL** Poproś rodziców o zgodę, zanim wejdiesz do Internetu | **CS** Než půjdeš na internet, požádej rodiče o svolení | **SK** Skôr než pôjdeš na internet, vypýtaj si povolenie od rodičov | **HU** Kérj szülői engedélyt, mielőtt online csatlakoznál! | **RO** Cere permisiunea părinților înainte de a te conecta online | **BG** Поискайте разрешение от родител, преди да влезете онлайн | **LV** Pirms došanās tiešsaistē palūdz atļauju vecākiem | **ET** Enne Interneti kasutamist küsi vanematelt luba | **LT** Prieš prisijungdami prie interneto, atsklauskite tėvų

[LEGO.com/devicecheck](https://www.lego.com/devicecheck)

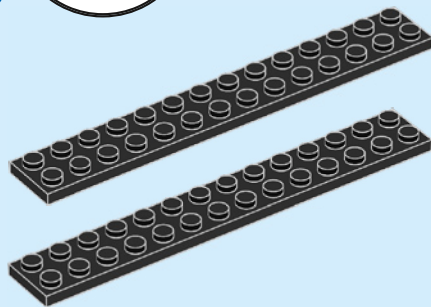
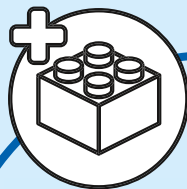

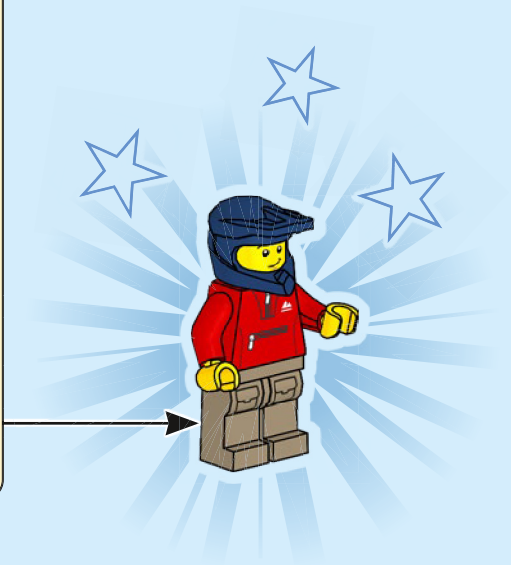
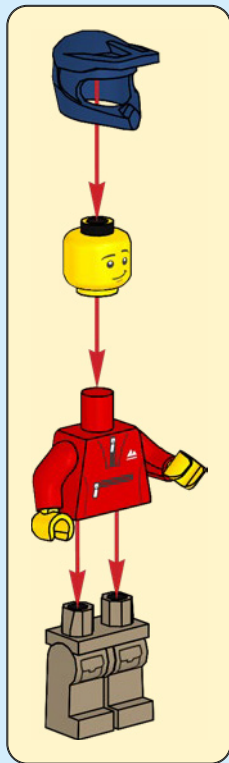

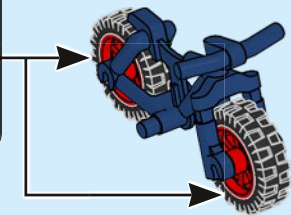
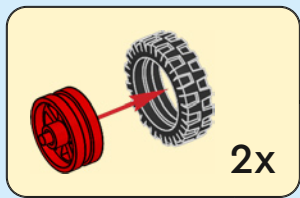





1x



1x

1

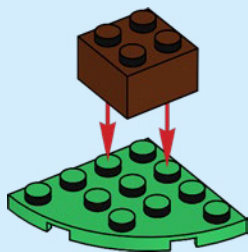

1x

2

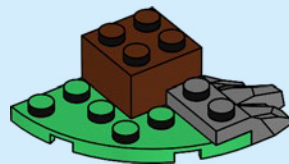

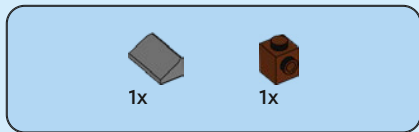

3

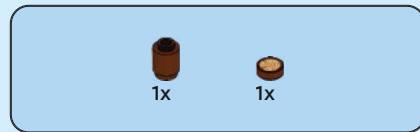
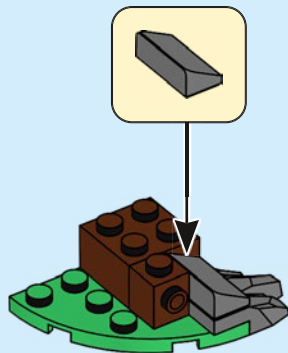

4

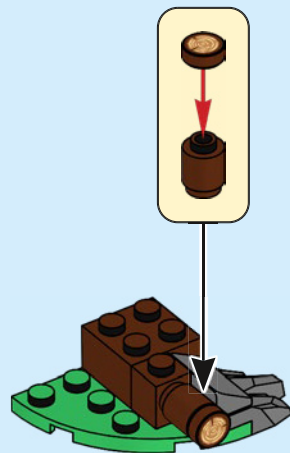



1x



1x

5

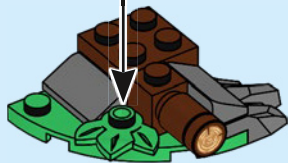

10



1x

6



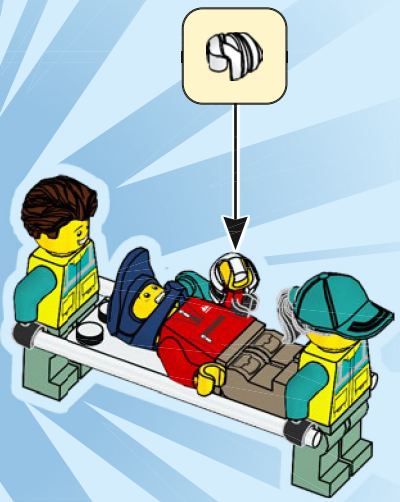
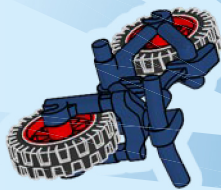

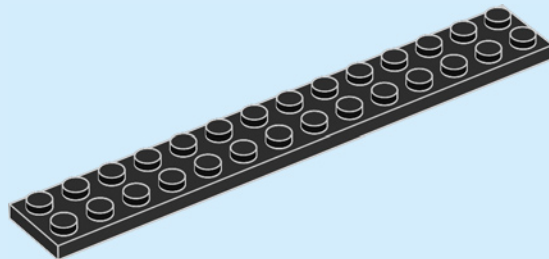
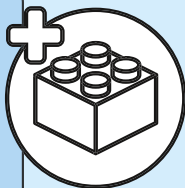
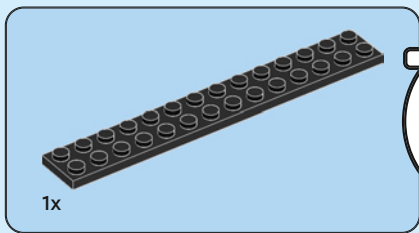
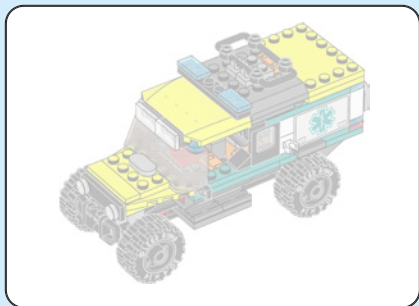

1



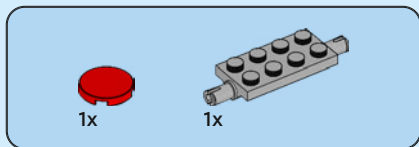

2

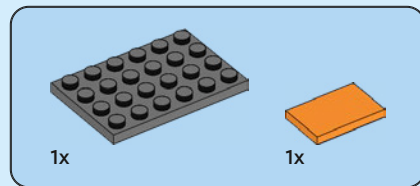
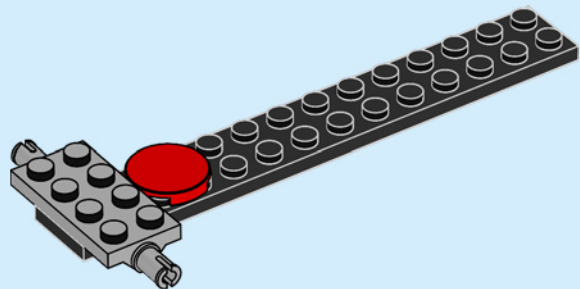

3

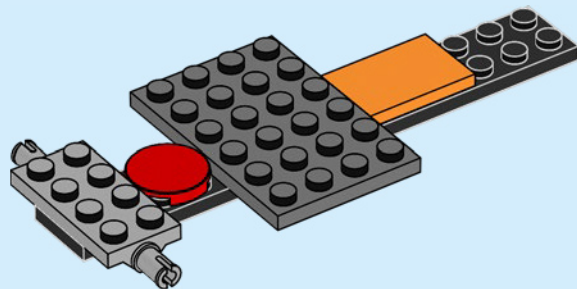

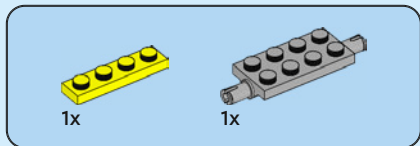

4

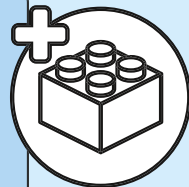
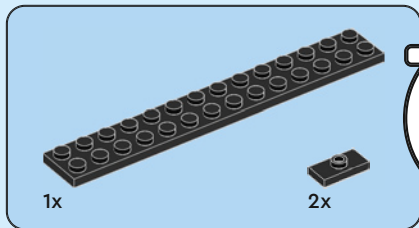
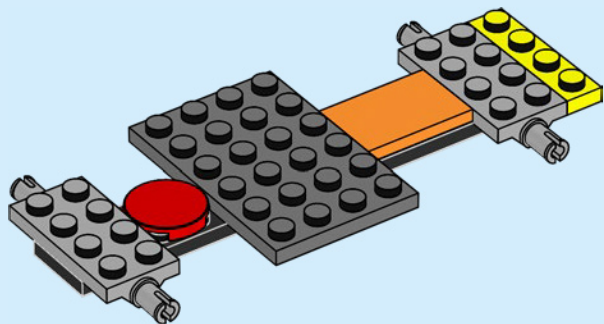

5

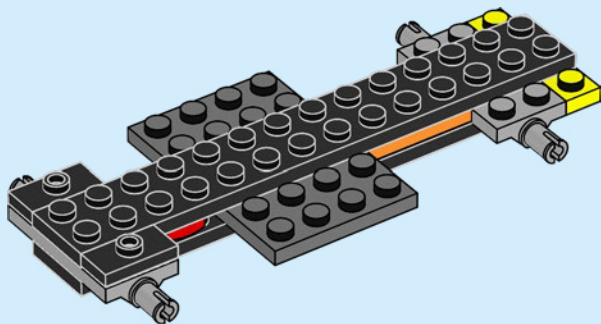

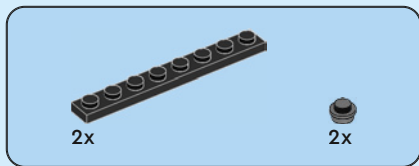

6

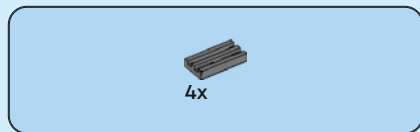
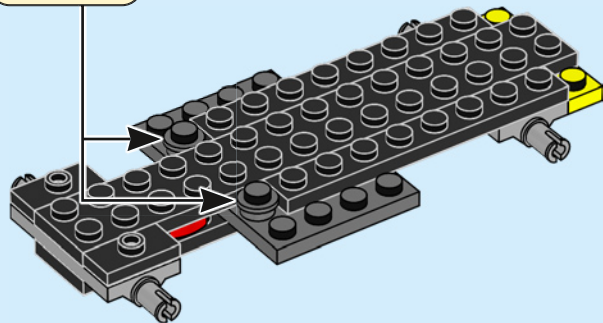

7

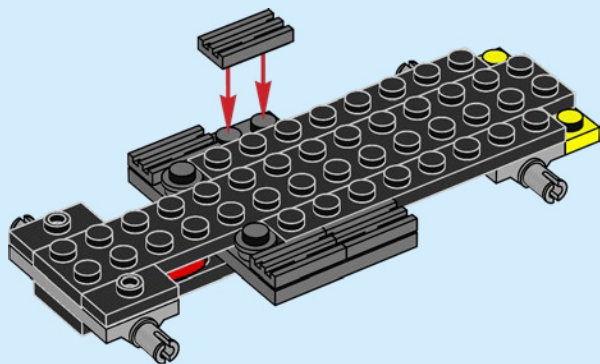



2x

8

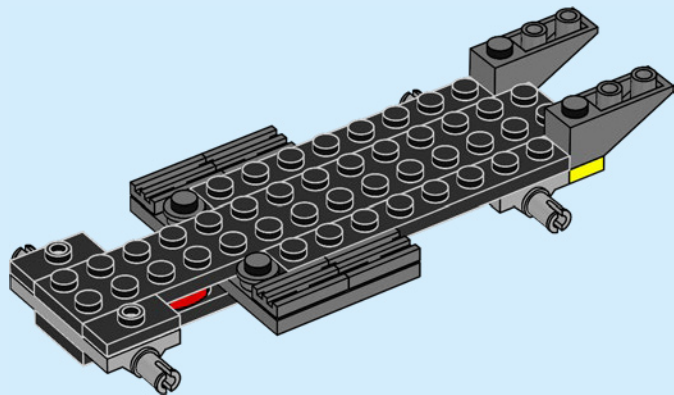



2x

9

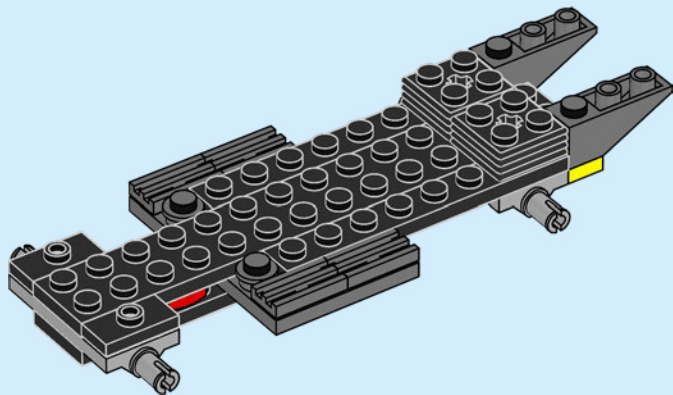



1x

10

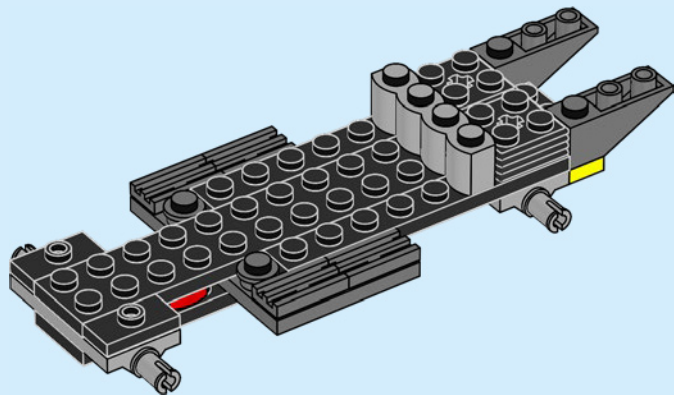

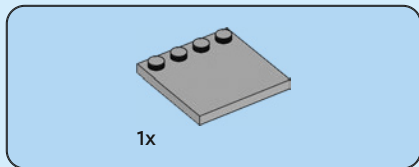

11

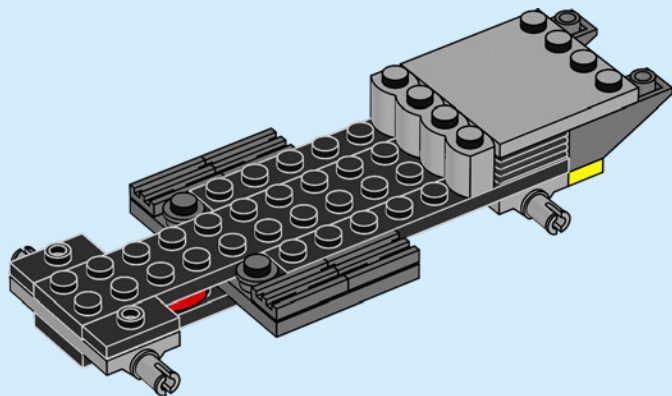



2x

12

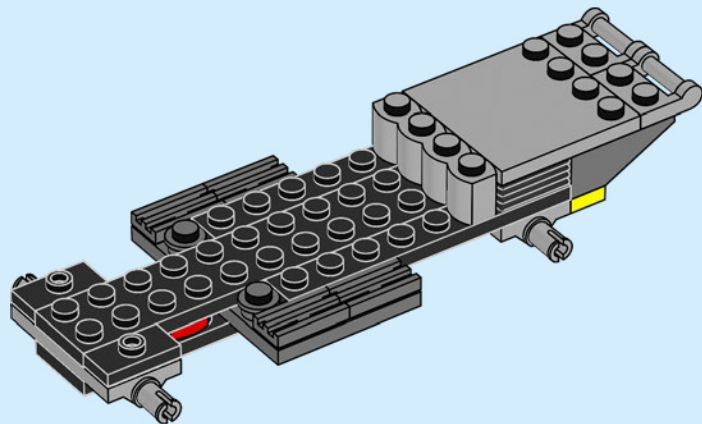

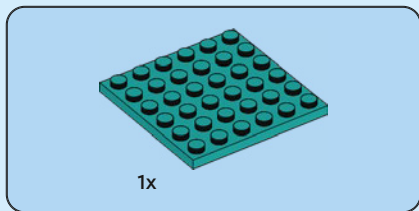

13

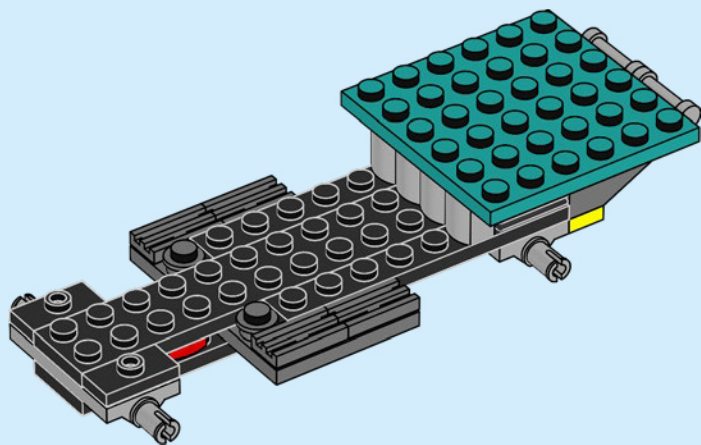

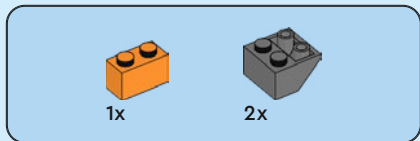

14

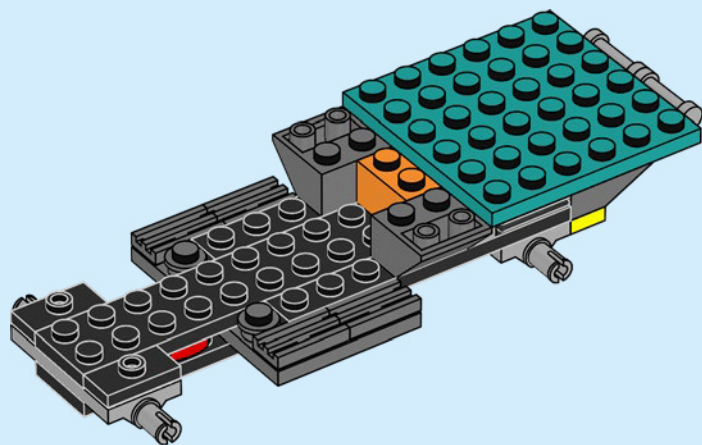



2x

15

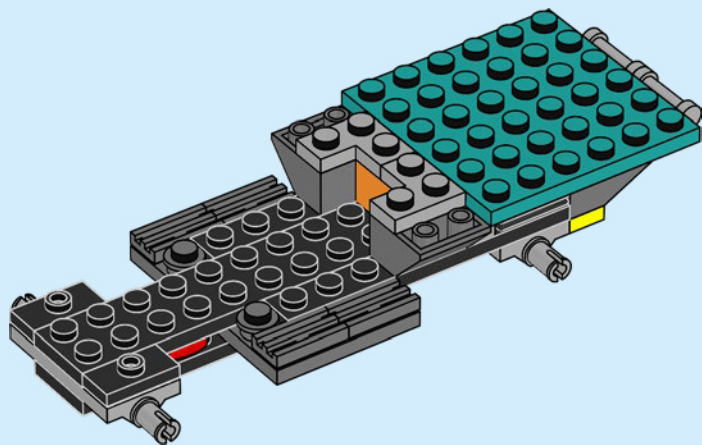

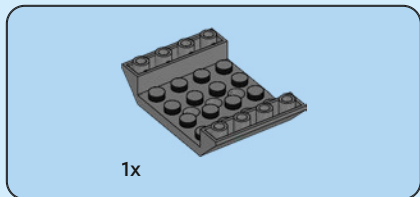

16

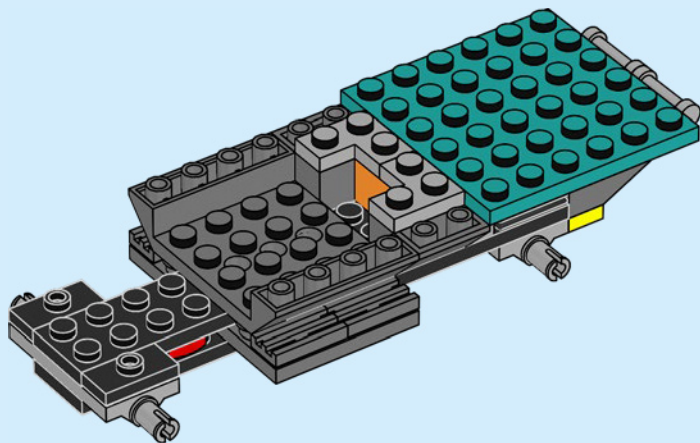

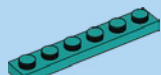

2x

17

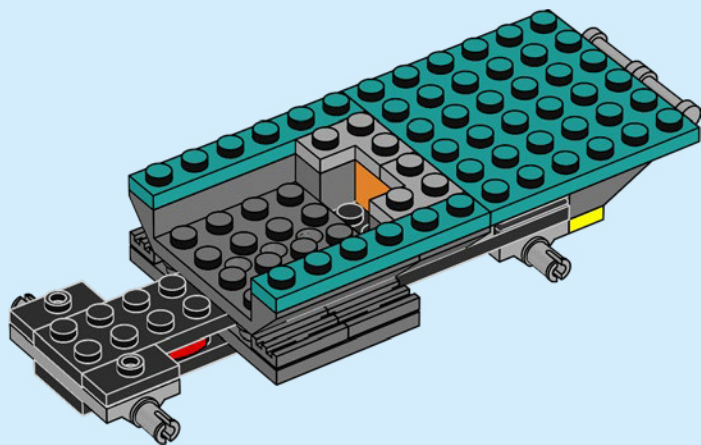



2x

18

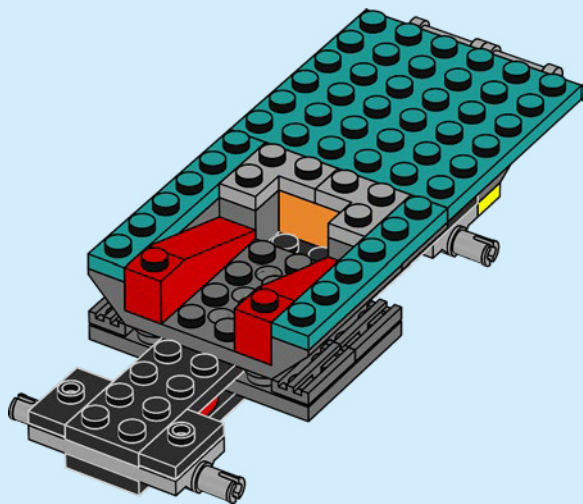



2x



1x

19

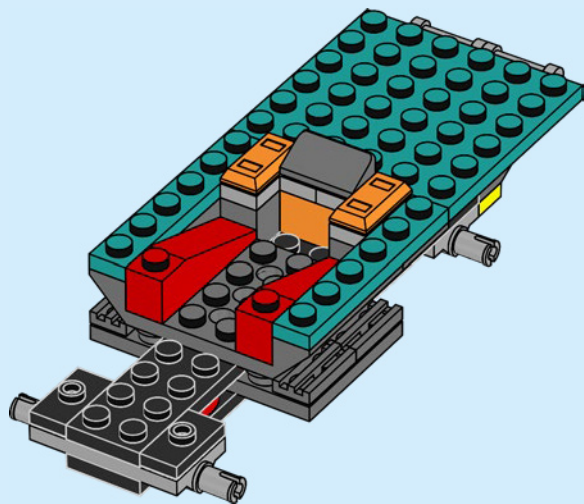

1x



1x

20

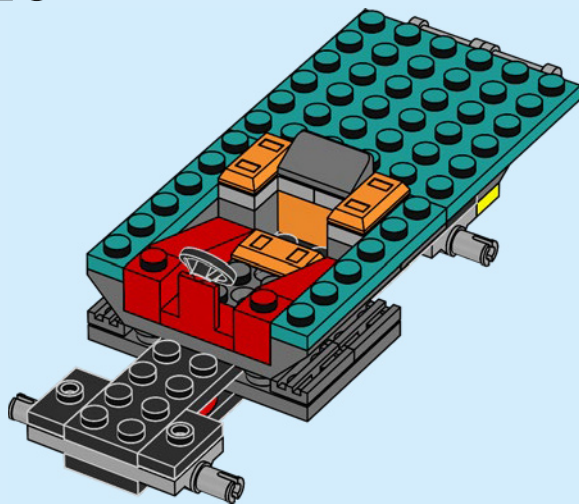

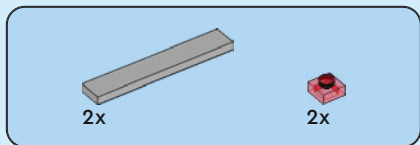

21

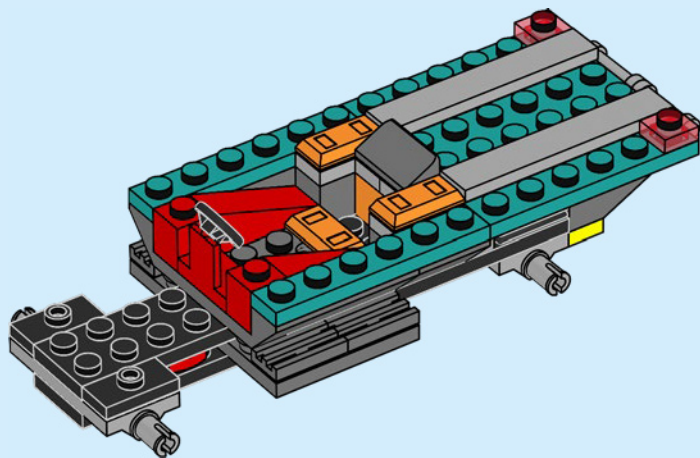



2x



2x

22

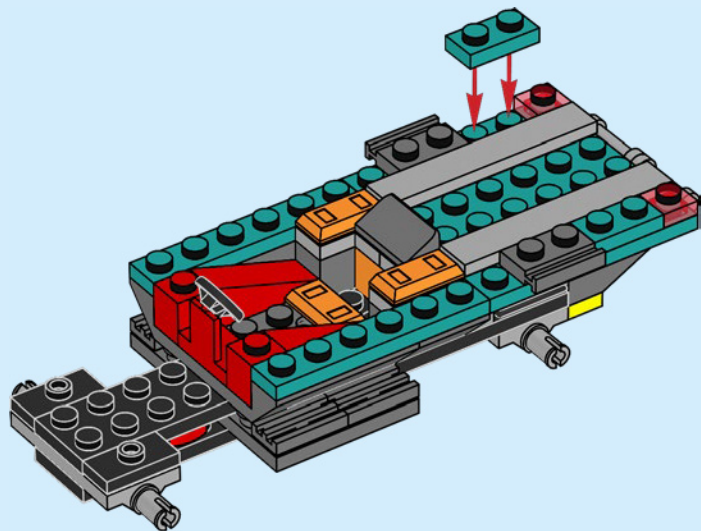

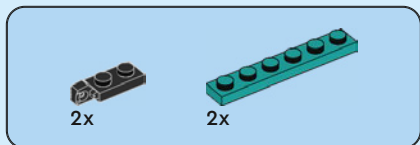

23

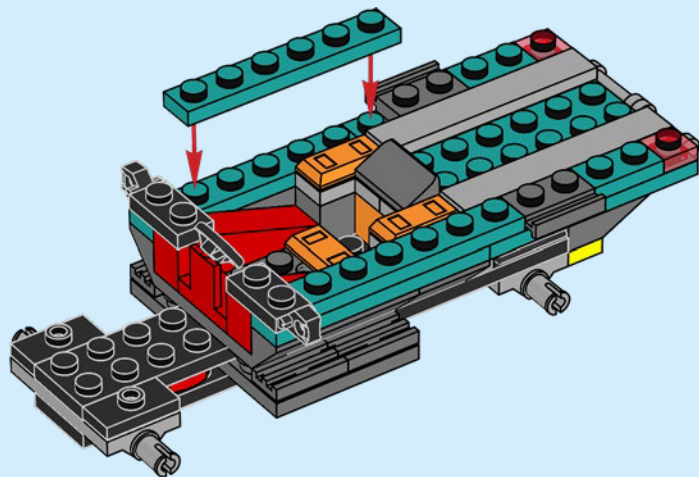

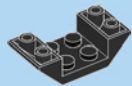

1x



1x

24

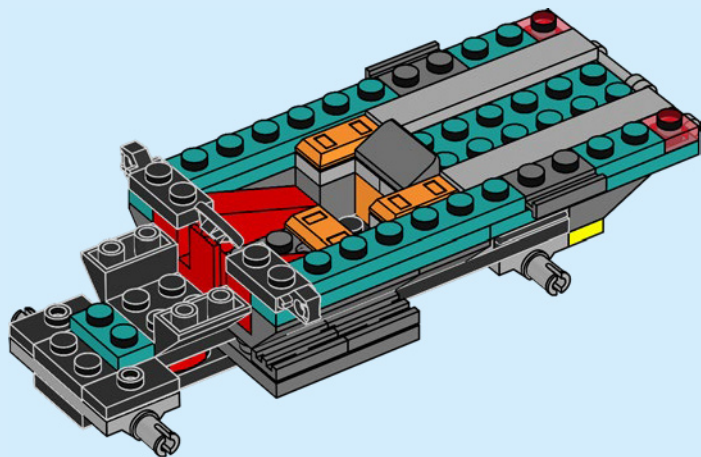

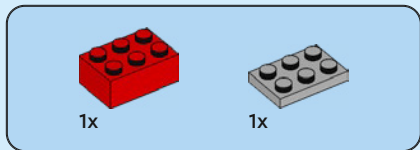

25

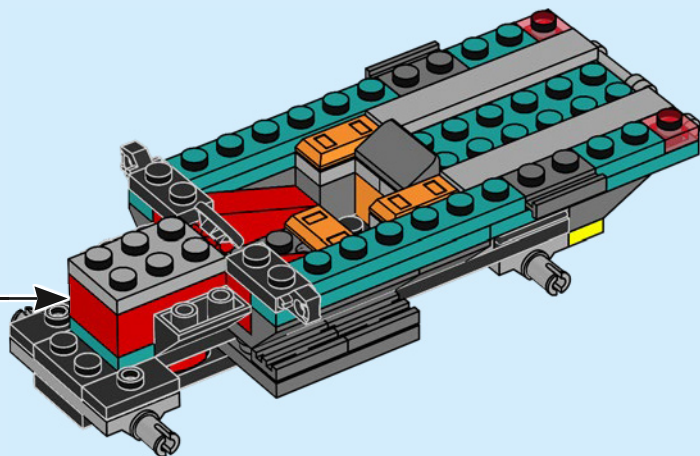
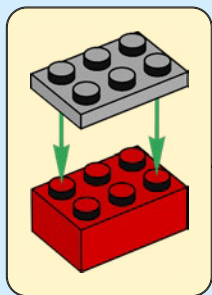



2x

26

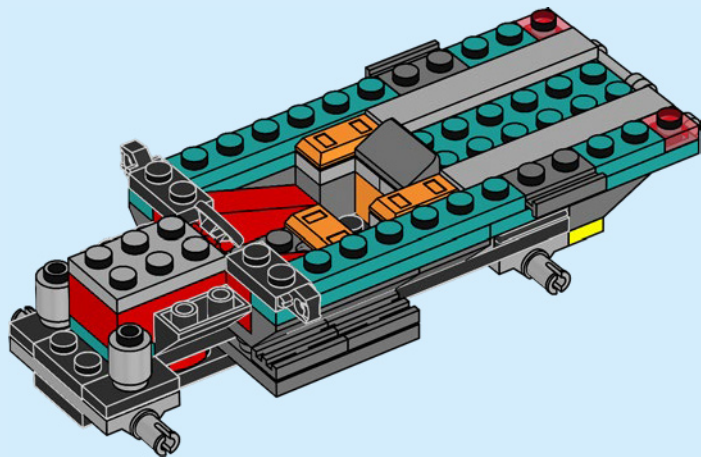



1x



2x

27

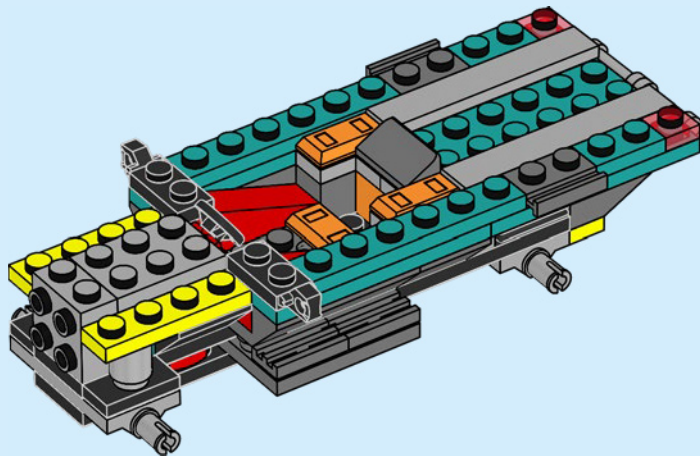



1x



1x

28

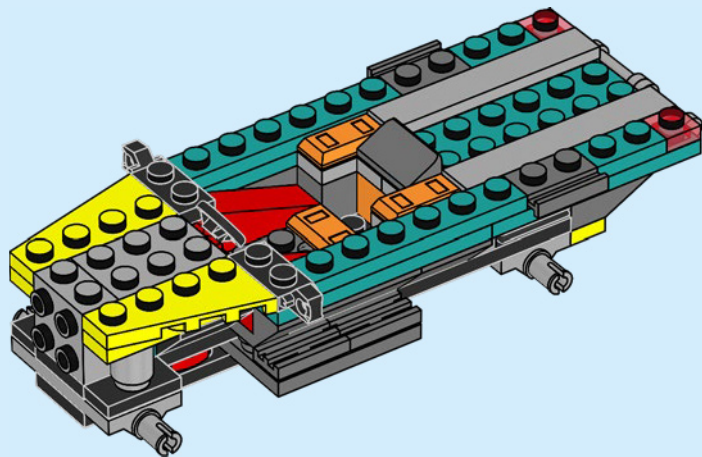



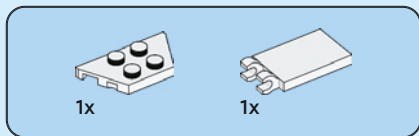

29

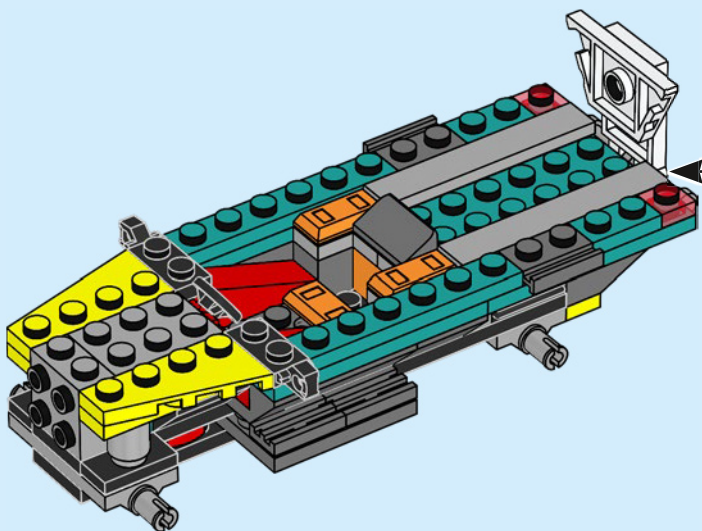
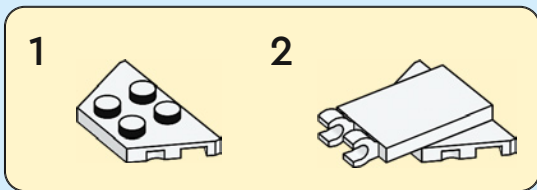



30

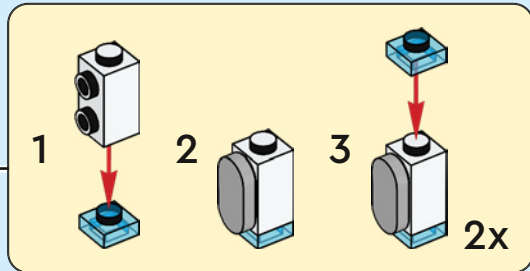
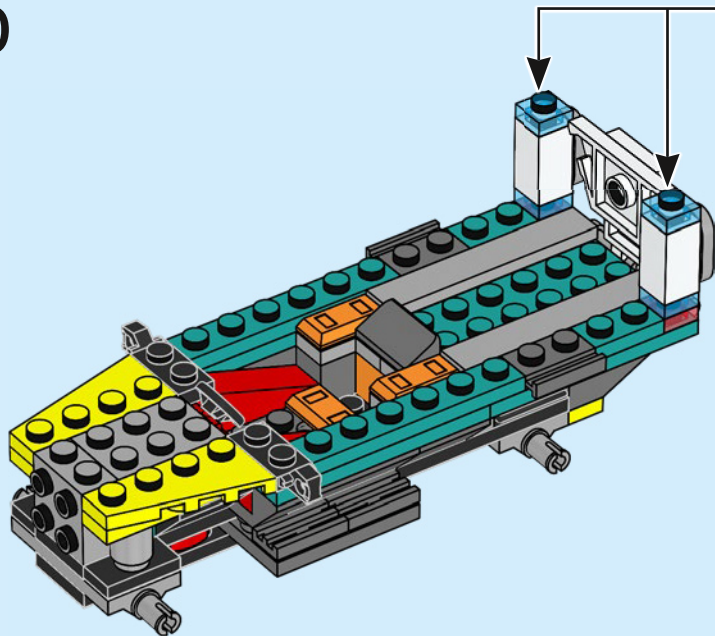

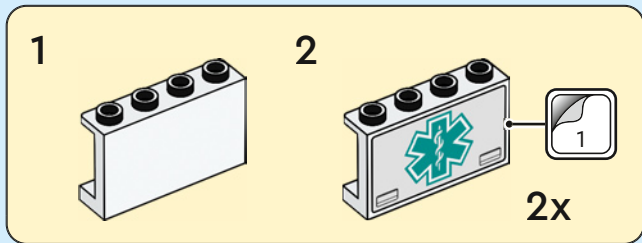
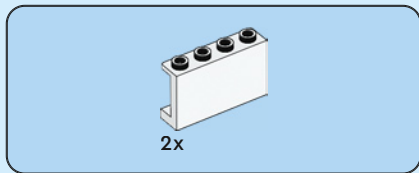

31

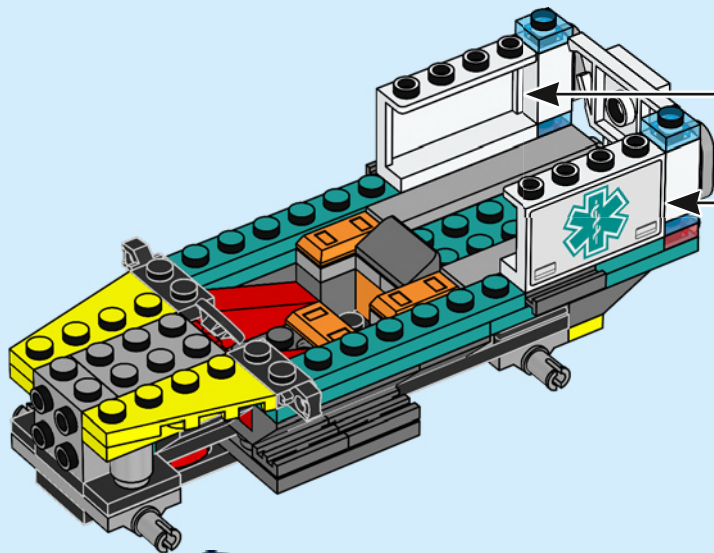



2x



2x

32



2x

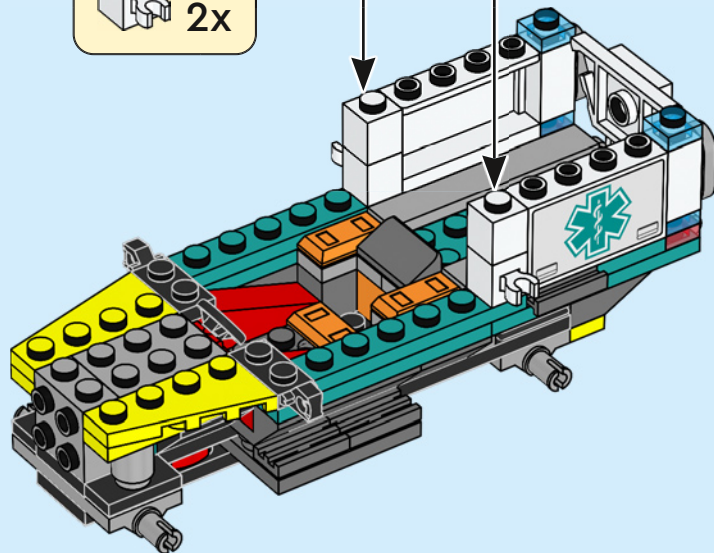

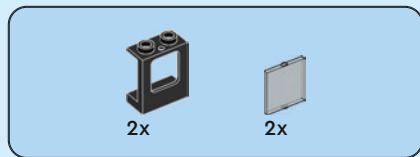

33

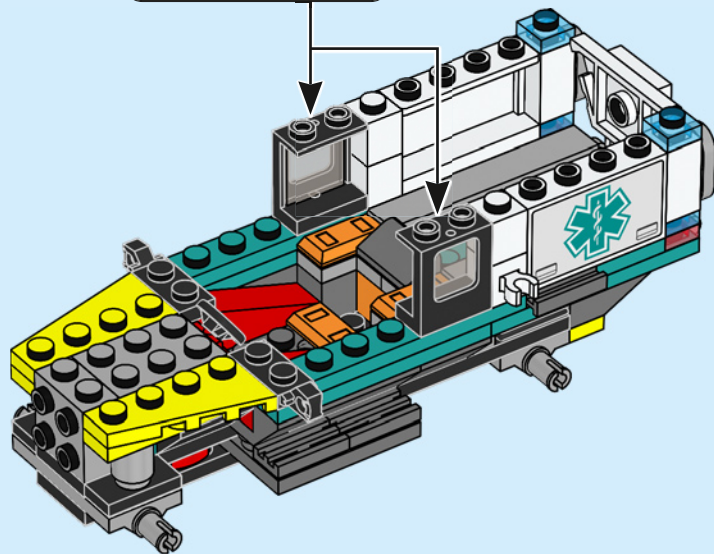
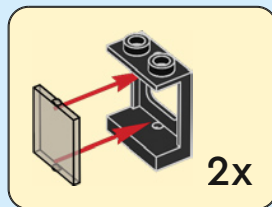

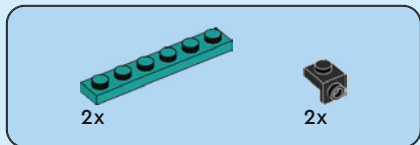

34

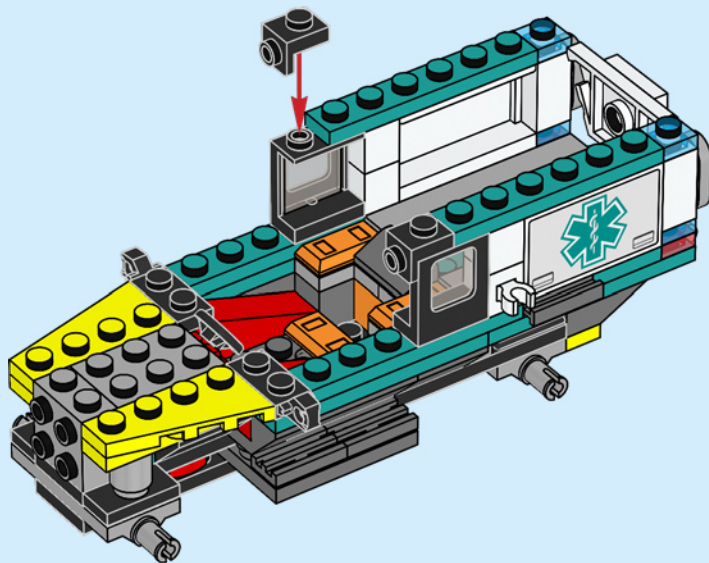



2x



2x



2x

35

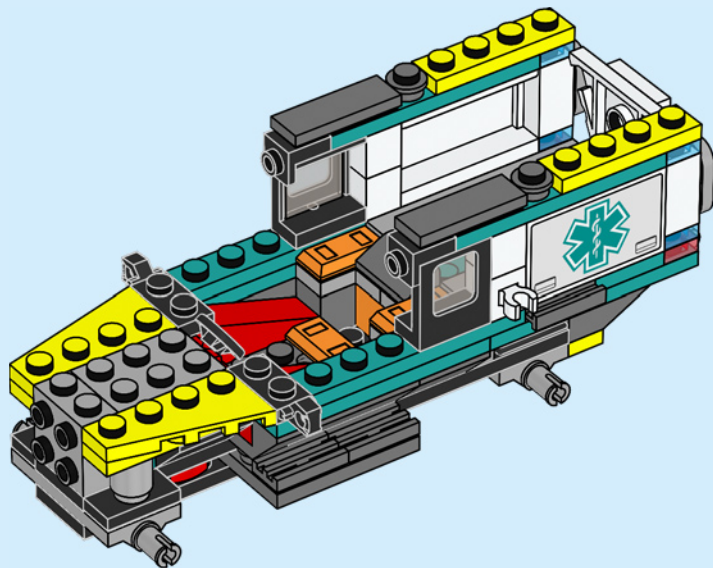

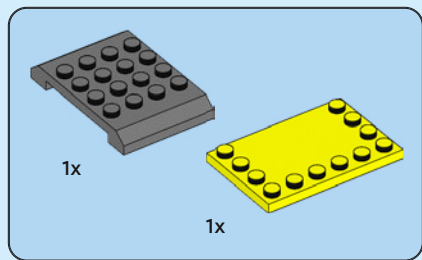

36

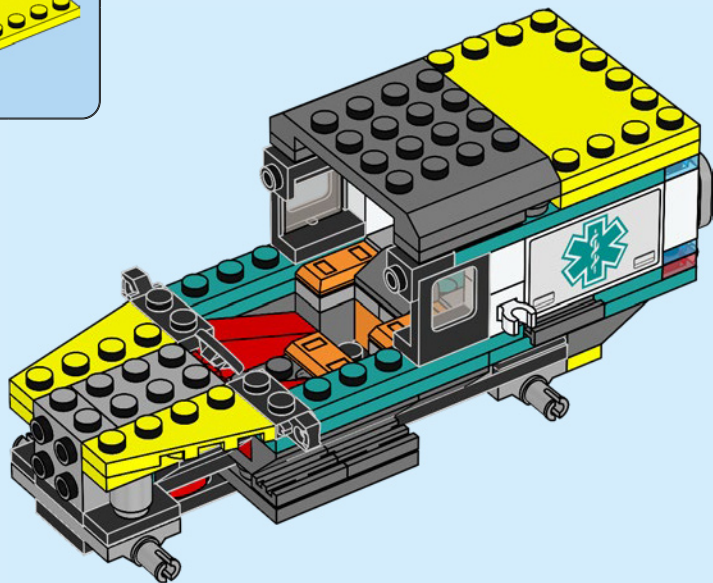



2x



2x

37

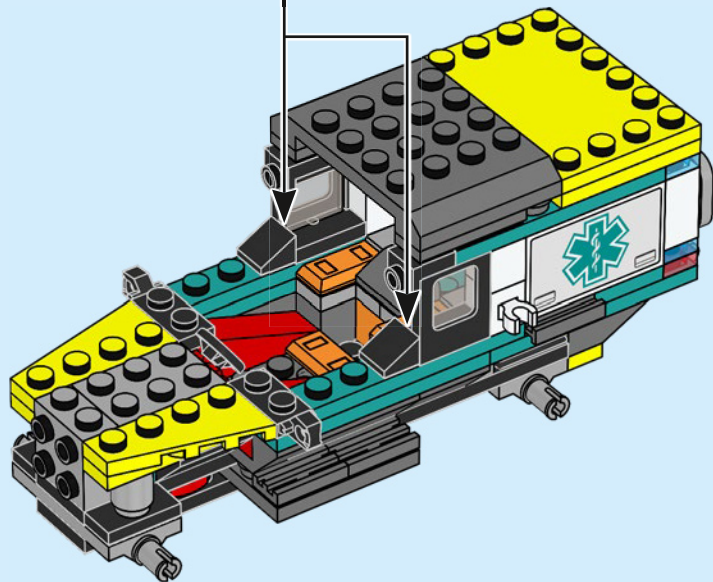

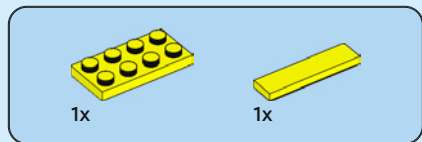

38

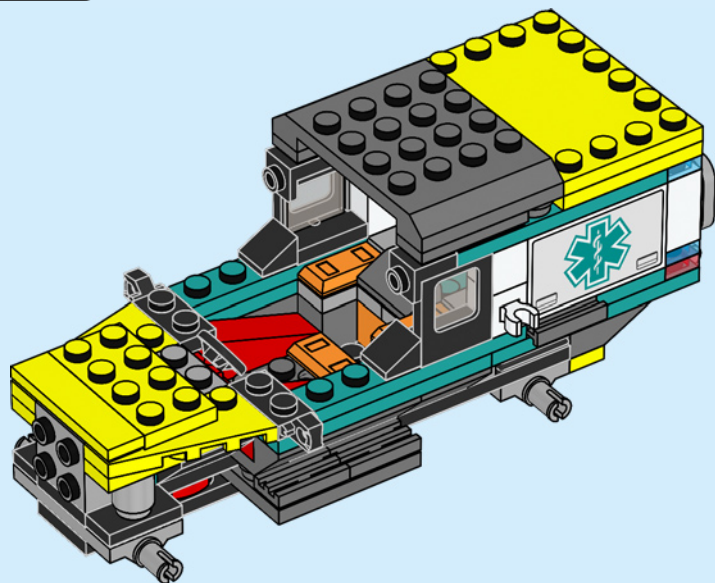

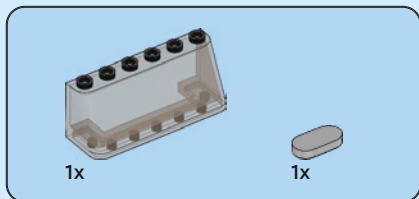

39

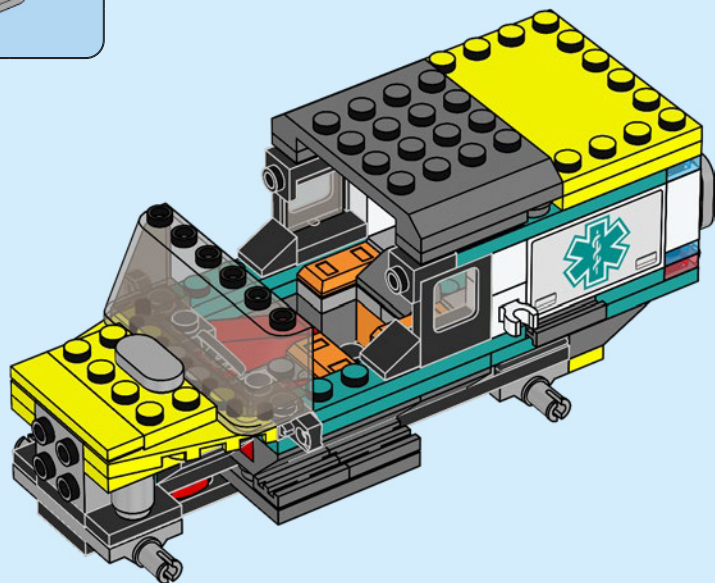



2x

40

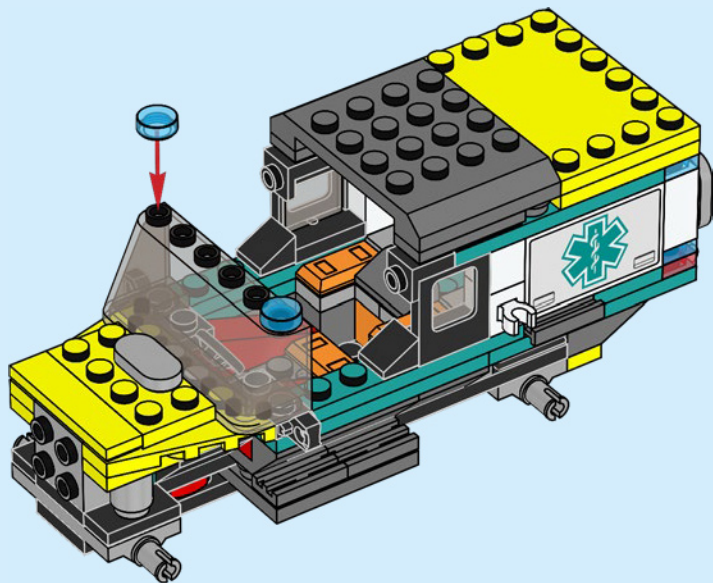



2x



2x

1



2

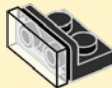

2x

41

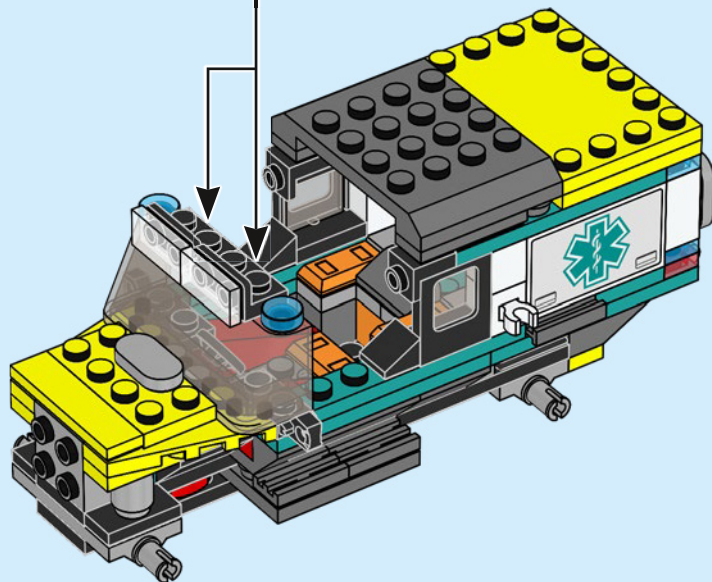

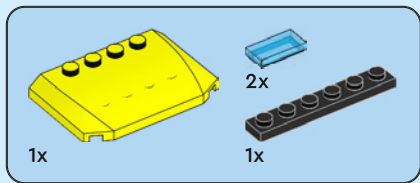

42

1

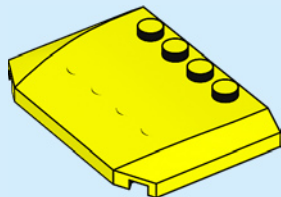

2

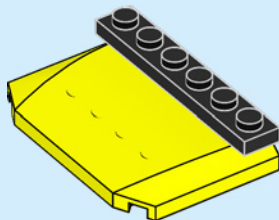

3

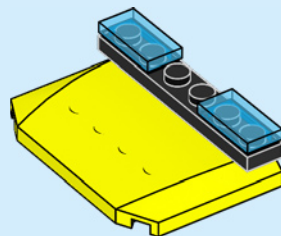

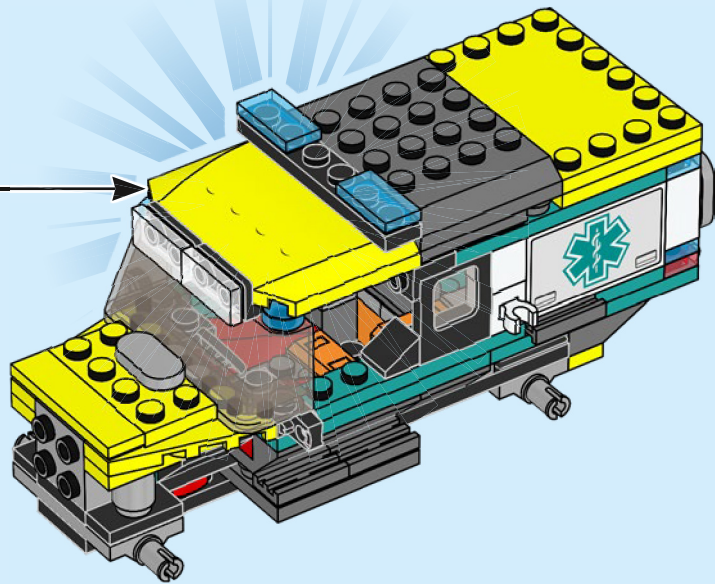



1x



2x

43

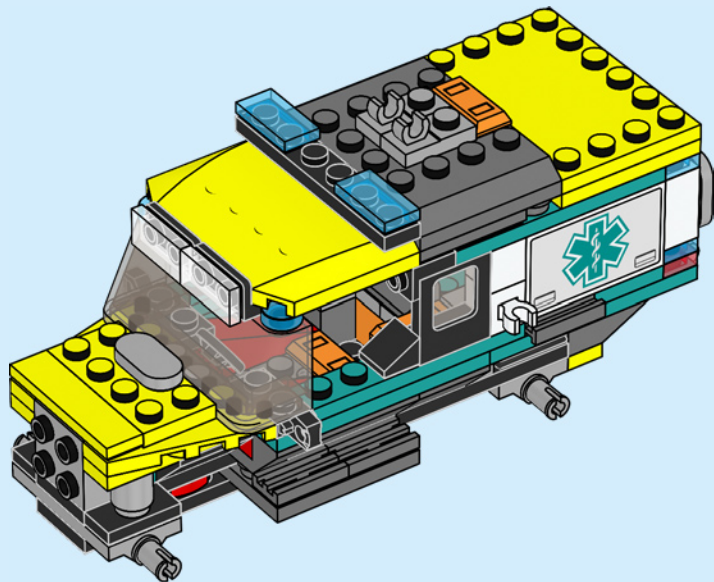



1x

44

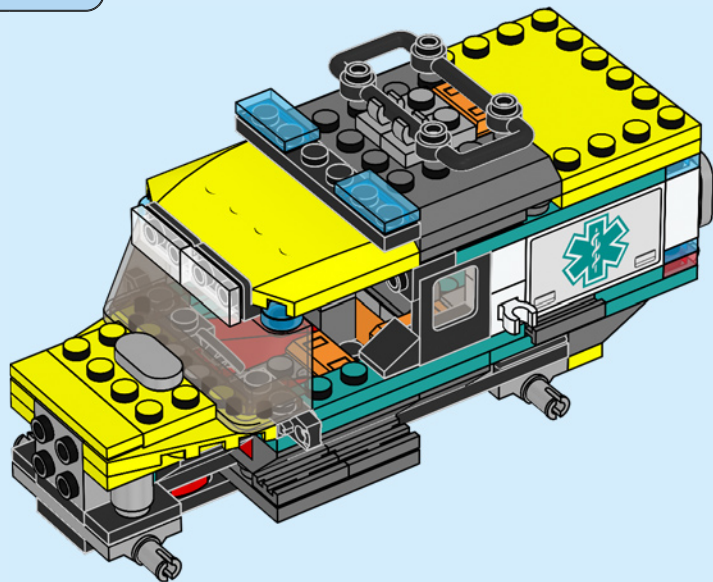



2x

45

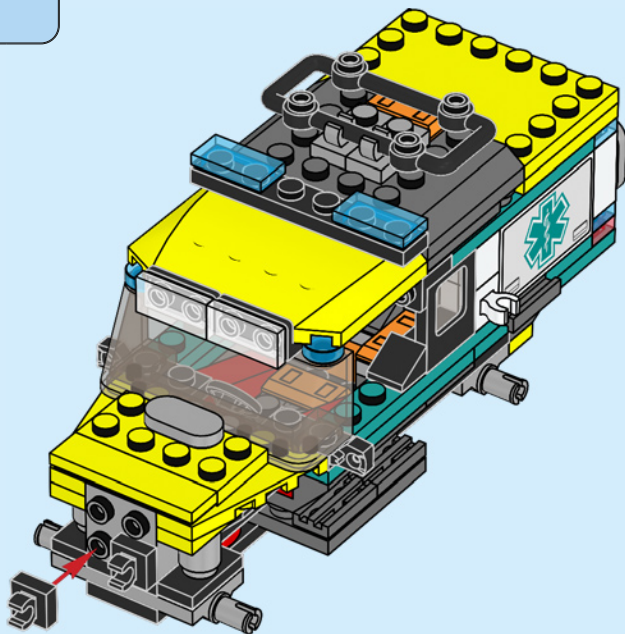



1x



2x

46

1

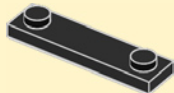

2

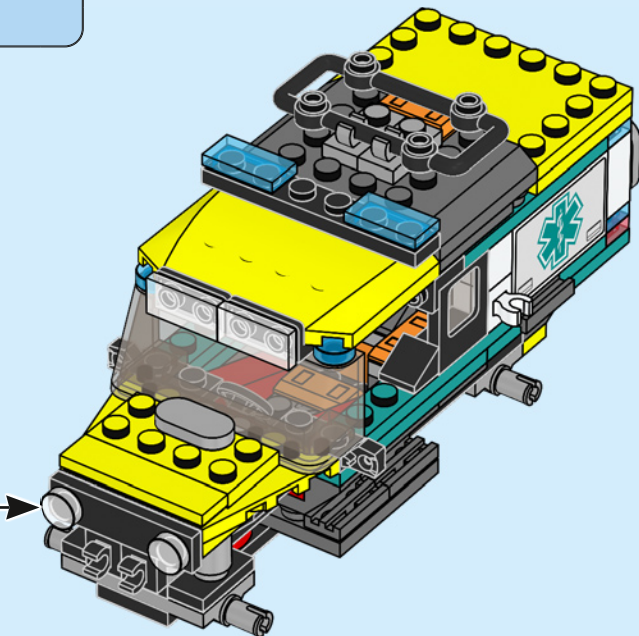
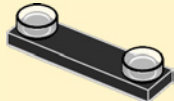



1x

47

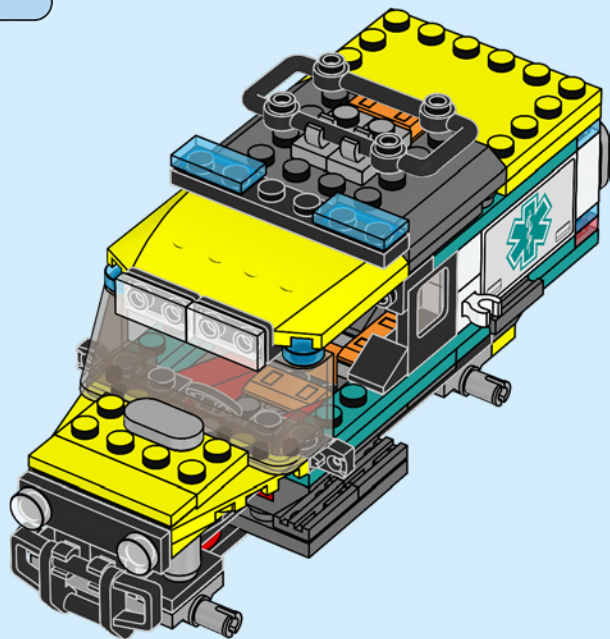

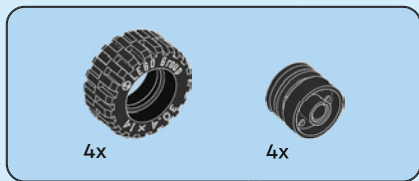

48

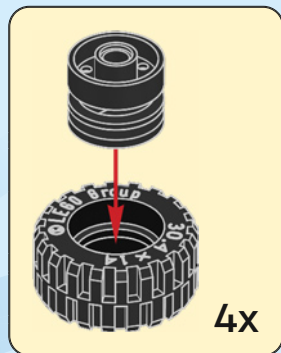
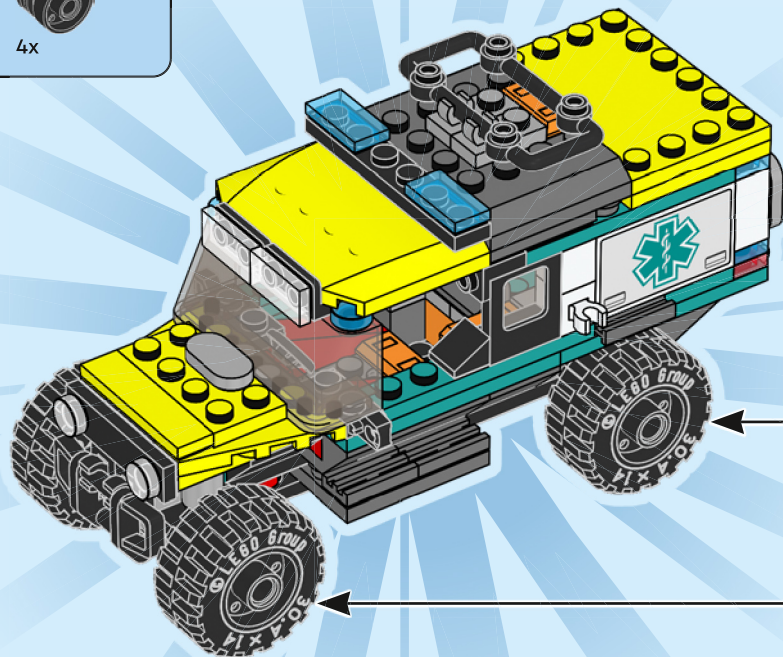

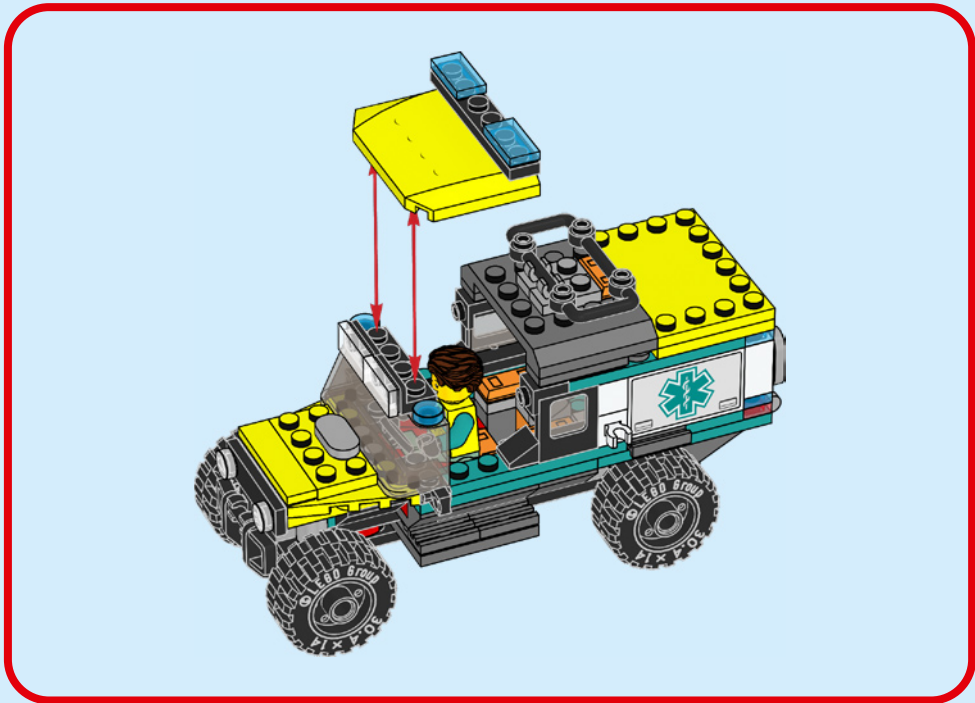

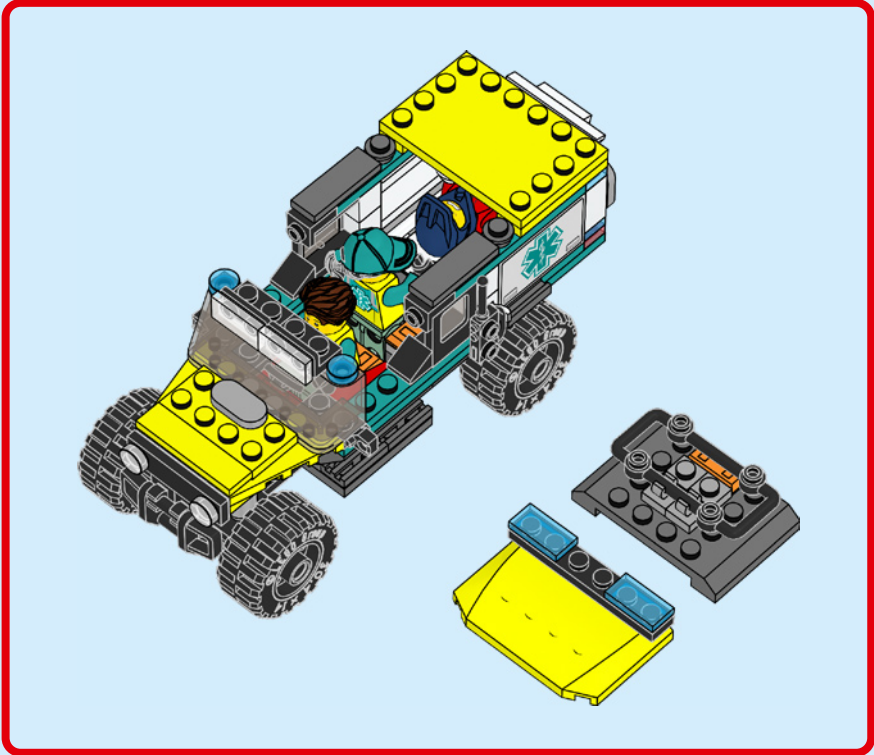

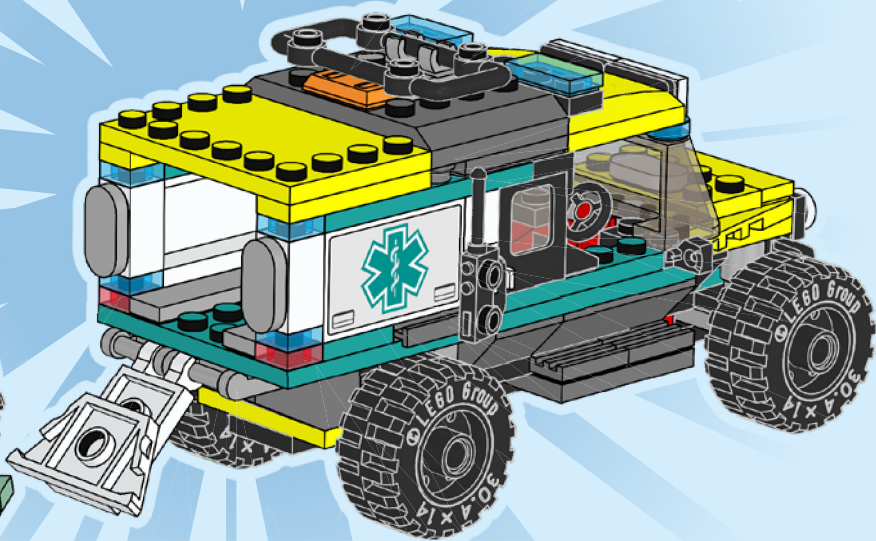
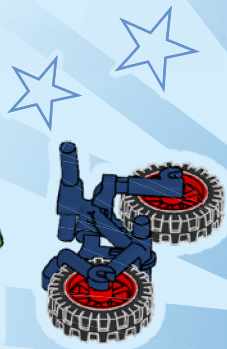



CITY



60372



60369



60373



60370



2x
300501



2x
6218841



2x
6321349



1x
6360131



1x
4249506



2x
6079140



1x
6192049



1x
6174454

62



1x
6153335



1x
6182787



1x
300221



2x
4515360



1x
6066342



2x
6413493



1x
9552



1x
6270336



2x
4504382



1x
4188534



2x
6092585



1x
6254045



1x
366626



2x
346026



2x
6335388



4x
4619323



2x
6299338



2x
6020193



2x
6266224



2x
4539128



1x
6172984



1x
6170545



4x
6359824



2x
6064174



1x
6207258



2x
6325254



1x
6038682



1x
6229130



1x
6268823



2x
6408542



4x
6252044



2x
6251289



2x
6273627



1x
4121739



1x
6293710



4x
6149656



3x
6213777



6x
6291782



2x
6254564



1x
6245192



1x
6343796



1x
6207255



1x
6331573



2x
4206504



1x
6371981



1x
4211210



1x
6062574



1x
4211183



1x
6285623



1x
6233224



1x
4211833



1x
6123809



2x
4211412



2x
4211353



1x
4211396



2x
4211549

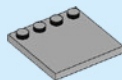

1x
4211837



2x
6326078



2x
4244627



3x
6412816



2x
4211000



2x
4211068

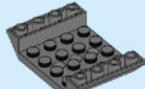

1x
4549999



4x
4210631



2x
4568734



1x
4211115



2x
4543086



3x
4567887



4x
4210633



1x
6226932



1x
6168609



2x
6378271



1x
6389817



5x
6380691

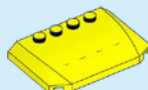

1x
6383020

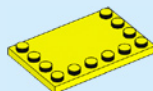

1x
6383021



1x
6371440



1x
6371443



1x
6388037



2x
6252042



2x
6251294



2x
6274738

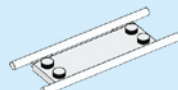

1x
4622575

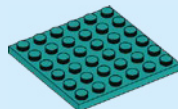

1x
6251830

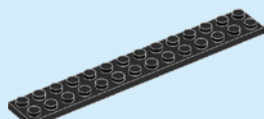

2x
6001494



LEGO.com/service



YOU COULD **WIN**



Scan this QR code or go to **LEGO.COM/PRODUCTFEEDBACK** and give us your short feedback about this LEGO® set for a chance to win a cool LEGO prize.

Terms and Conditions apply*

DE: Du könntest GEWINNEN. Es gelten die Teilnahmebedingungen* **FR: Tu pourrais GAGNER.** Des conditions s'appliquent* **IT: Potresti VINCERE tu.** Termini e condizioni sono applicabili* **ES: Puedes GANAR.** Aplican términos y condiciones* **PT: Poderá GANHAR.** Aplicam-se termos e condições* **JA: プレゼント付き! 利用規約が適用されます*** **ZH: 轻松获奖. 条款和条件适用*** **KO: 상품의 주인이 되어보세요. 소정의 약관이 적용됩니다*** **RU: Вы можете ВЫИГРАТЬ.** Действуют положения и условия* **PL: Szansa na WYGRANĄ.** Obowiązują warunki korzystania* **CS: Máte šanci VYHRÁT.** Platí všeobecné smluvní podmínky* **SK: Máte šancu VYHRAŤ.** Platia všeobecné zmluvné podmienky* **HU: TE IS NYERHETSZ.** Felhasználási feltételek érvényesek* **RO: Ai putea CÂȘTIGA.** Se aplică termeni și condiții* **BG: Можете да СПЕЧЕЛИТЕ.** Има определени правила и условия* **LV: Tu vari LAIMĒT.** Ir spēkā noteikumi un nosacījumi.* **ET: Sul on võimalus VÕITA.** Kehtivad tingimused* **LT: Jūs galite LAIMĖTI.** Taikomos sąlygos*
*LEGO.com/productfeedback-terms